



VETOMED SURGIX

# SURGICAL FORCEPS

SMALL ANIMALS  
LARGE ANIMALS  
EQUINES



+92 311 697 7280  
[vetomedurgix.com](http://vetomedurgix.com)  
[contact@vetomedurgix.com](mailto:contact@vetomedurgix.com)



# VETOMED SURGIX

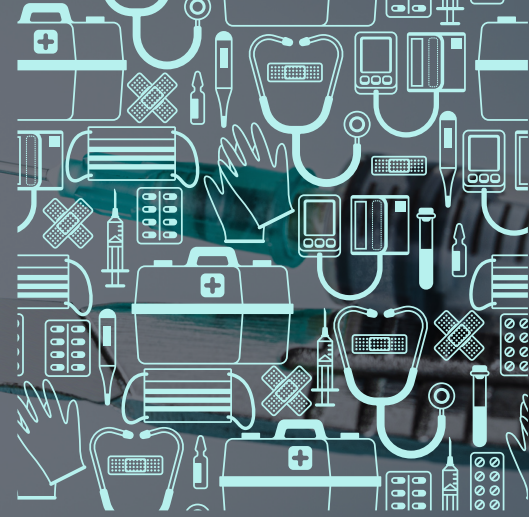

# COMPANY PROFILE

*You Think, We Design*



## ABOUT US :



### OUR GOAL

Our goal is to make veterinary surgery more efficient, effective, and affordable for our customers. We are working with leading experts and researchers in the field to develop and export innovative surgical instruments that can solve the most challenging problems in animal surgery.



### OUR VISION

Our vision is to become the preferred partner for veterinary surgery, offering a wide range of products and services that cater to the diverse needs of our customers. We aspire to create a lasting impact on the world by improving the health and well-being of animals and their owners.



### OUR MISSION

Our mission is to provide the best surgical instruments for veterinarians and animal health professionals around the world. We believe that every animal deserves the best care possible, and we are committed to delivering high-quality products that meet the highest standards of safety and performance.

## OUR SERVICES



Exporting premium quality surgical instruments to various countries, ensuring timely delivery and customer satisfaction.



Designing and customizing surgical instruments according to customers' specifications and needs, using our slogan "You think, we design".



Consulting and advising customers on the best surgical equipment and techniques for their specific cases, drawing from our expertise and research.

## WHY CHOOSE US?

We are a trusted ally who understands your needs and challenges. We are a creative partner who can design and customize surgical instruments according to your specifications. We are a reliable supplier who can deliver high-quality products at competitive prices.

## CONTACT US

+92 311 697 7280 (VetoMed Surgix)



[www.vetomed surgix.com](http://www.vetomed surgix.com)



[contact@vetomed surgix.com](mailto:contact@vetomed surgix.com)



Plaza No.17, DHA Phase II,  
Islamabad, Pakistan

Zange  
Forceps  
Forcipe  
مناظ



# Forceps





**WERTHEIM  
VM-1001**  
23,0 cm, 9"



**VM-1002**



**VM-1003**



**MAINGOT  
VM-1004**  
21,5 cm, 8 1/2"

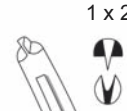

**VM-1005**

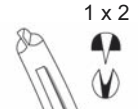

**VM-1006**



**MOYNIHAN  
VM-1007**

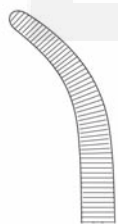

**VM-1008**  
23,0 cm, 9"

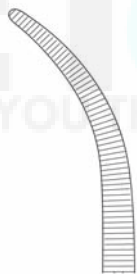

**VM-1009**  
24,0 cm, 9 1/2"



**WERTHEIM-CULLEN  
VM-1010**  
21,5 cm, 8 1/2"

**VM-1011**

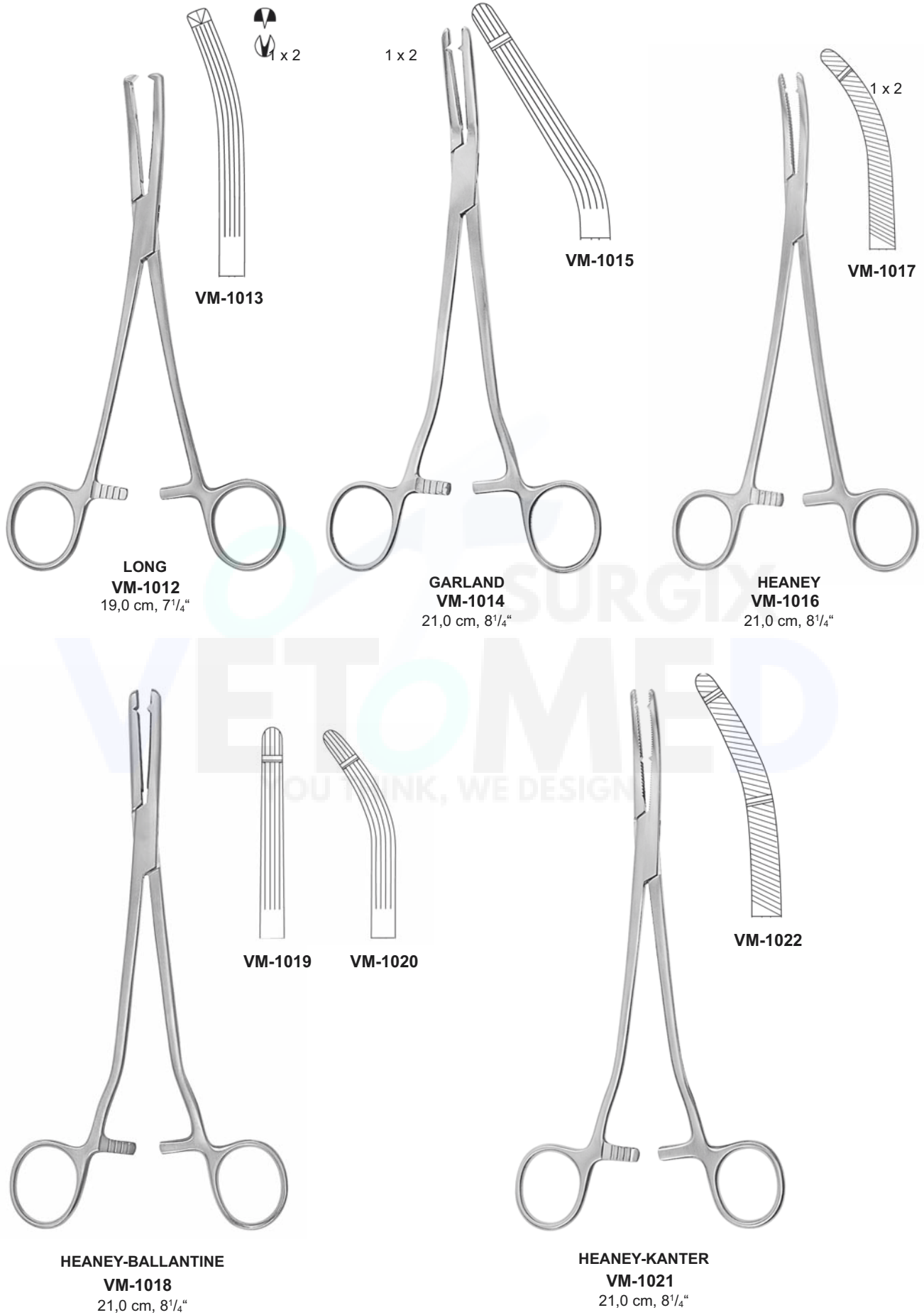

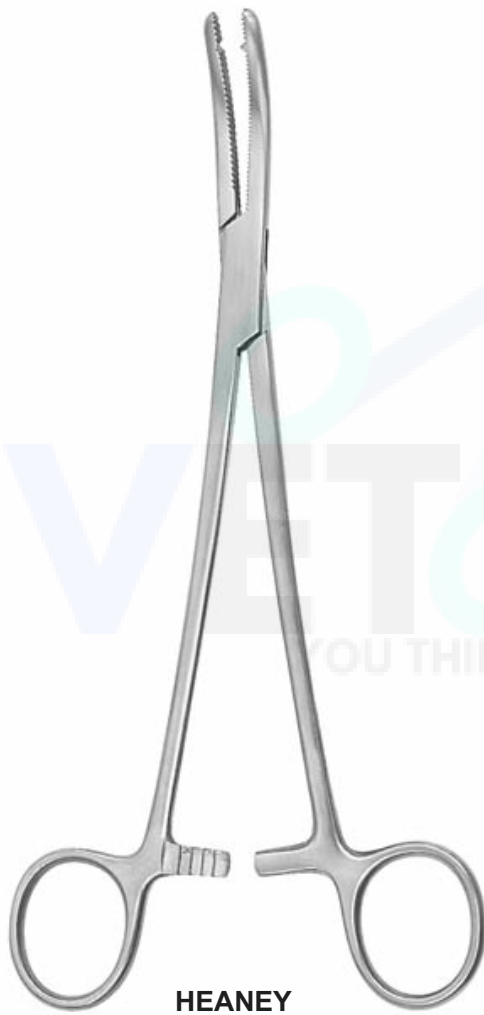

HEANEY  
VM-1023

21,0 cm, 8<sup>1</sup>/<sub>4</sub>"  
23,0 cm, 9"



VM-1024

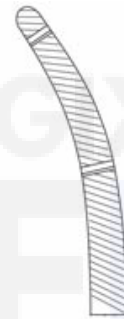

VM-1025



3,5 cm, 1 1/2"  
 5,0 cm, 2"

**DIEFFENBACH**  
**VM-1026**



**VM-1027**



**VM-1028**



**HESS**  
**VM-1029**

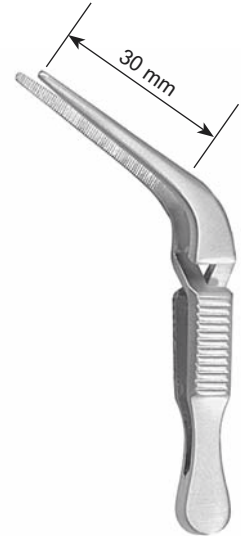

**HESS**  
**VM-1030**



3,8 cm, 1 1/2"  
 5,0 cm, 2"  
 6,3 cm, 2 1/2"  
 7,6 cm, 3"  
 9,0 cm, 3 1/2"

**JOHNS-HOPKINS**  
**VM-1031**



**VM-1032**



**VM-1033**



**JOHNS-HOPKINS**  
**VM-1034**  
 23,0 cm, 9"



with non-traumatic serration

L	
7,5 cm, 3"	2,5 cm, 1"
8,5 cm, 3 <sup>1</sup> / <sub>4</sub> "	3,5 cm, 1 <sup>3</sup> / <sub>8</sub> "
10,5 cm, 4 <sup>1</sup> / <sub>8</sub> "	5,0 cm, 2"
12,0 cm, 4 <sup>3</sup> / <sub>4</sub> "	6,8 cm, 2 <sup>3</sup> / <sub>4</sub> "

DE BAKEY  
VM-1035



with non-traumatic serration

L	
7,0 cm, 2 <sup>3</sup> / <sub>4</sub> "	2,5 cm, 1"
8,0 cm, 3 <sup>1</sup> / <sub>8</sub> "	3,5 cm, 1 <sup>3</sup> / <sub>8</sub> "
10,0 cm, 3 <sup>3</sup> / <sub>4</sub> "	5,0 cm, 2"
11,5 cm, 4 <sup>1</sup> / <sub>2</sub> "	6,8 cm, 2 <sup>3</sup> / <sub>4</sub> "

DE BAKEY  
VM-1036



TITANIUM  
VM-1037  
3,5 cm, 1<sup>3</sup>/<sub>8</sub>"



TITANIUM  
VM-1038  
3,5 cm, 1<sup>3</sup>/<sub>8</sub>"



TITANIUM  
VM-1039  
4,0 cm, 1<sup>5</sup>/<sub>8</sub>"



TITANIUM  
VM-1040  
4,0 cm, 1<sup>5</sup>/<sub>8</sub>"



# Bulldog Clamps, Intestinal Tissue Grasping Forceps

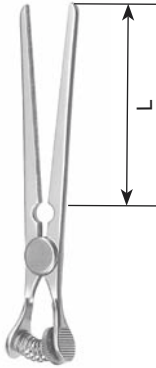

L	
6,8 cm, 2 <sup>3</sup> / <sub>4</sub> "	3,3 cm, 1 <sup>3</sup> / <sub>8</sub> "
9,6 cm, 3 <sup>3</sup> / <sub>4</sub> "	5,0 cm, 2"
11,7 cm, 4 <sup>3</sup> / <sub>4</sub> "	6,9 cm, 2 <sup>3</sup> / <sub>4</sub> "

**GLOVER**  
**VM-1041**

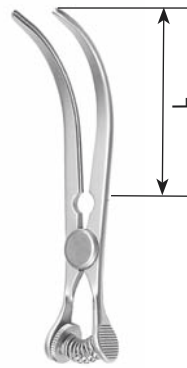

L	
6,5 cm, 2 <sup>1</sup> / <sub>2</sub> "	3,3 cm, 1 <sup>3</sup> / <sub>8</sub> "
9,1 cm, 3 <sup>1</sup> / <sub>2</sub> "	5,0 cm, 2"
11,0 cm, 4 <sup>3</sup> / <sub>8</sub> "	6,9 cm, 2 <sup>3</sup> / <sub>4</sub> "

**GLOVER**  
**VM-1042**



**VM-1044**

**CHAPUT**  
**VM-1043**  
 13,0 cm, 5"



**VM-1046**

**TUFFIER**  
**VM-1045**  
 13,0 cm, 5"



**VM-1048**

**COLLIN**  
**VM-1047**  
 16,0 cm, 6<sup>1</sup>/<sub>4</sub>"

## Intestinal and Tissue Grasping Forceps



**PENNINGTON**  
**VM-1049**

15,5 cm, 6"  
 20,0 cm, 8"



**ATRAUMA**  
**VM-1051**



**VM-1052**  
 25,0 cm, 9<sup>3</sup>/<sub>4</sub>"



**VM-1053**  
 27,0 cm, 10<sup>1</sup>/<sub>2</sub>"



**MARTEL**  
**VM-1054**  
 14,0 cm, 5<sup>1</sup>/<sub>2</sub>"

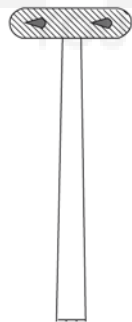

**VM-1055**

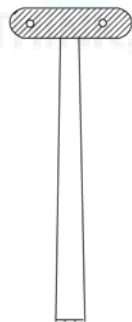

**VM-1056**

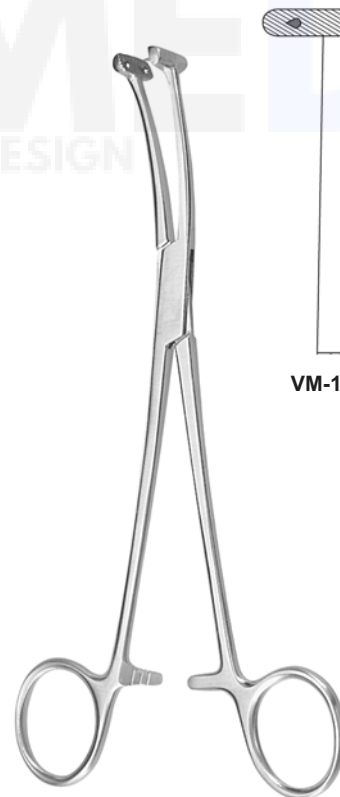

**WILLET-MARTEL**  
**VM-1057**  
 19,0 cm, 7<sup>1</sup>/<sub>2</sub>"

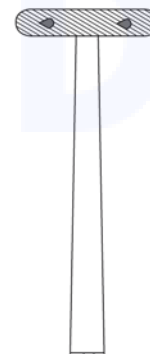

**VM-1058**

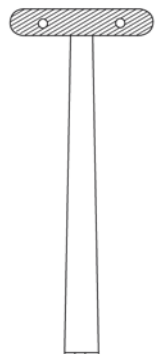

**VM-1059**

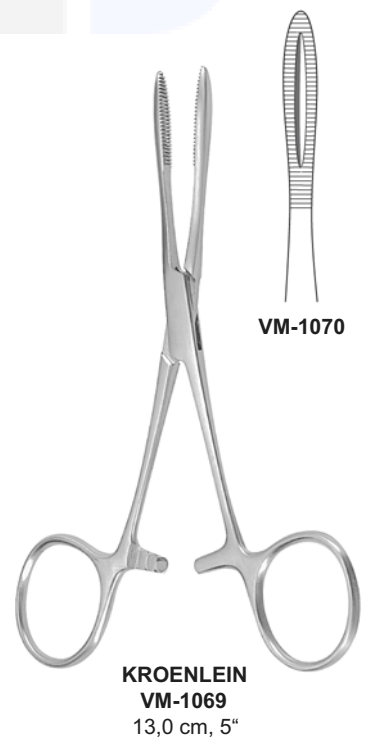
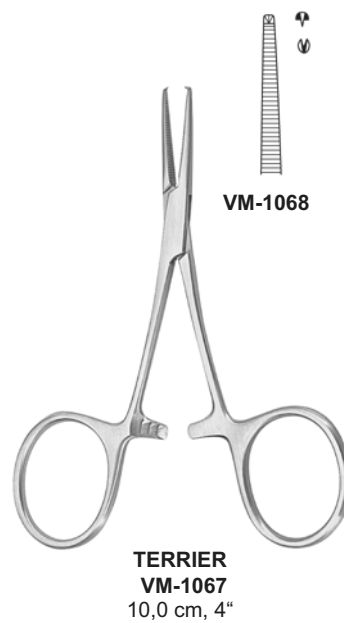
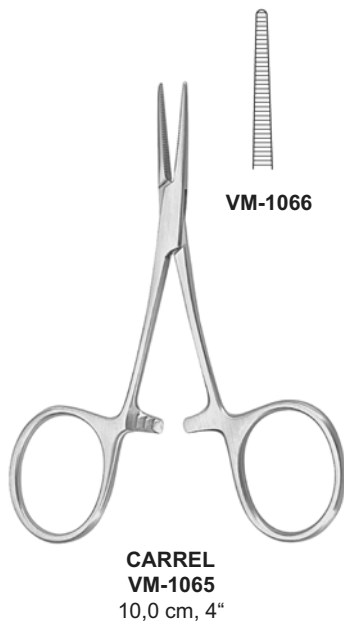
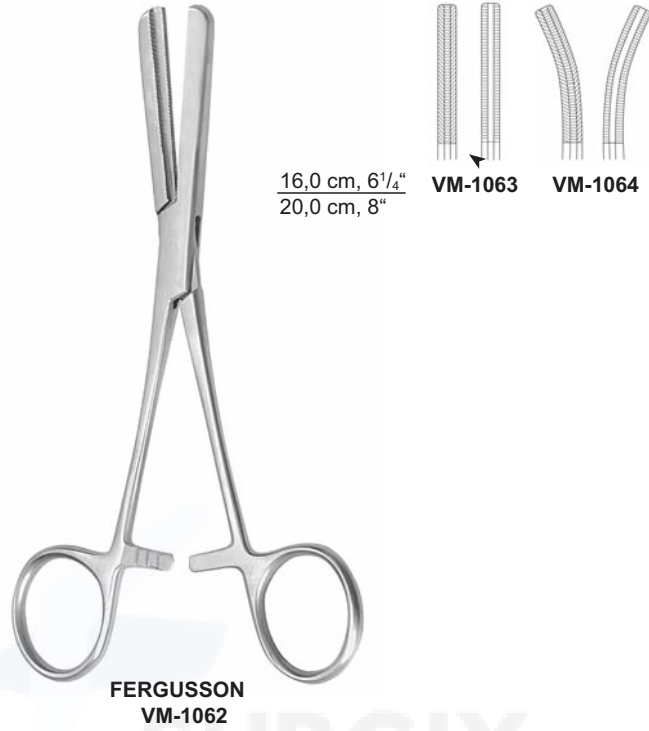

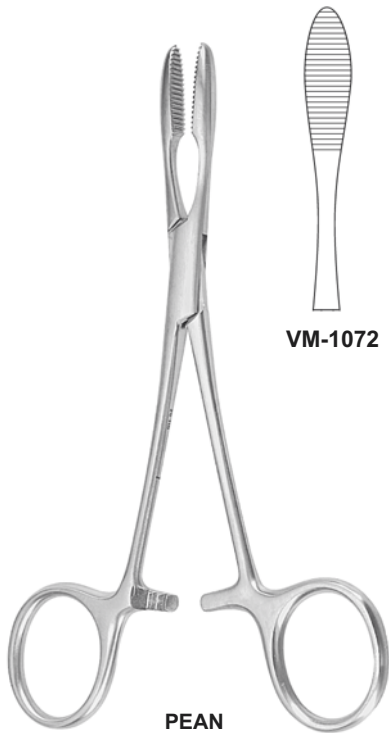

VM-1072

PEAN  
VM-1071  
14,0 cm, 5 1/2"  
16,0 cm, 6 1/4"

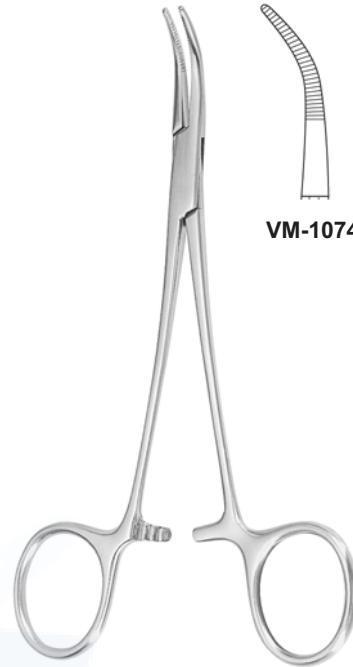

VM-1074

BABY-MIXTER  
VM-1073  
14,0 cm, 5 1/2"

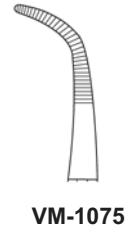

VM-1075



13,0 cm, 5"  
15,0 cm, 6"  
18,0 cm, 7"  
20,0 cm, 8"

SPENCER-WELLS  
VM-1076

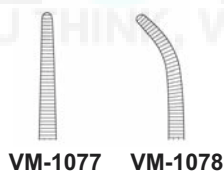

VM-1077 VM-1078

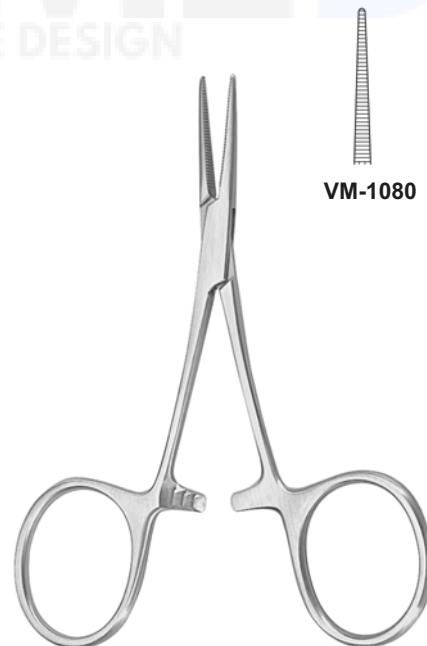

HARTMANN  
VM-1079  
10,0 cm, 4"

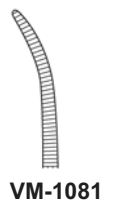

VM-1080 VM-1081

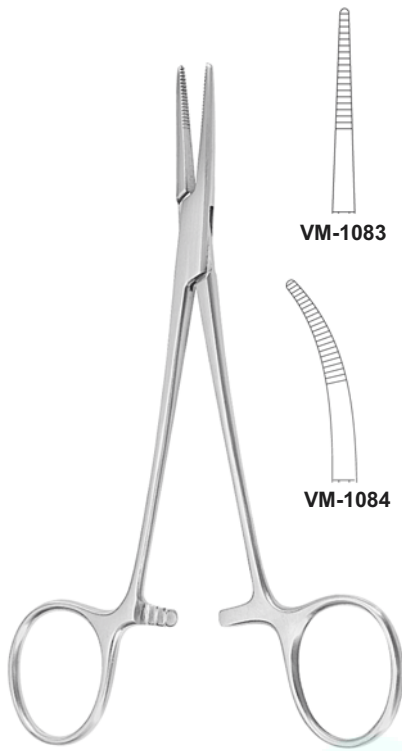

**PROVINCENCE-HOSPITAL**  
**VM-1082**  
 14,0 cm, 5½"



**HALSTED-MOSQUITO**  
**VM-1085**

12,5 cm, 5"  
 25,0 cm, 9¾"

**VM-1086** **VM-1087**

12,5 cm, 5"  
 25,0 cm, 9¾"

1 x 2      1 x 2  
**VM-1088** **VM-1089**



**HALSTED-MOSQUITO**  
**VM-1090**

**VM-1091**  
 18,0 cm, 7"

**VM-1092**  
 18,0 cm, 7"

**VM-1093**  
 21,0 cm, 8¼"

**VM-1094**  
 21,0 cm, 8¼"

1 x 2  
**VM-1095**  
 18,0 cm, 7"

1 x 2  
**VM-1096**  
 18,0 cm, 7"

1 x 2  
**VM-1097**  
 21,0 cm, 8¼"

1 x 2  
**VM-1098**  
 21,0 cm, 8¼"



**MICRO-MOSQUITO**  
**VM-1099**

10,0 cm, 4"  
 12,0 cm, 4¾"

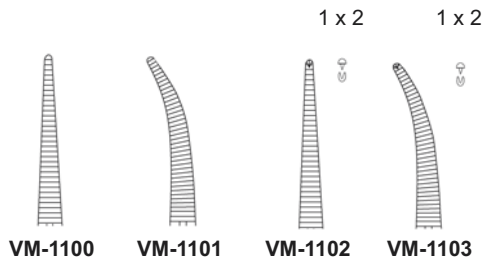

**VM-1100**

**VM-1101**

**VM-1102**

**VM-1103**

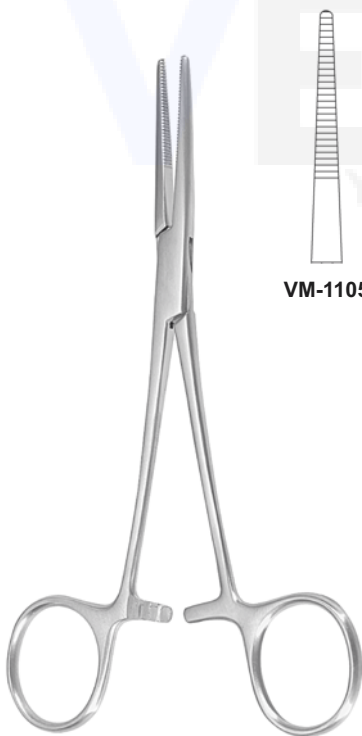

**KELLY**  
**VM-1104**  
 14,0 cm, 5½"

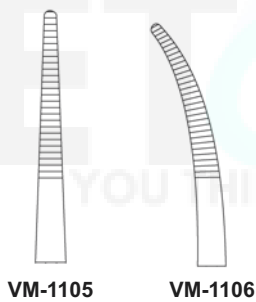

**VM-1105**

**VM-1106**

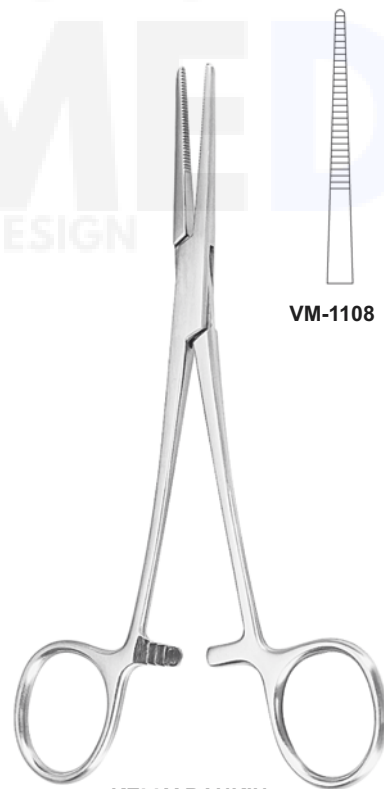

**KELLY-RANKIN**  
**VM-1107**  
 16,0 cm, 6¼"

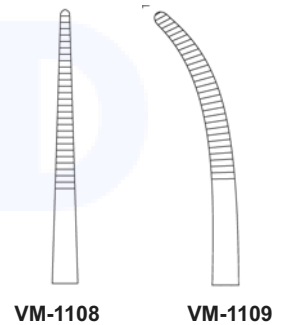

**VM-1108**

**VM-1109**



**LERICHE**  
**VM-1110**  
 15,0 cm, 6"



**VM-1111**



**VM-1112**

1 x 2



**VM-1113**

1 x 2



**VM-1114**

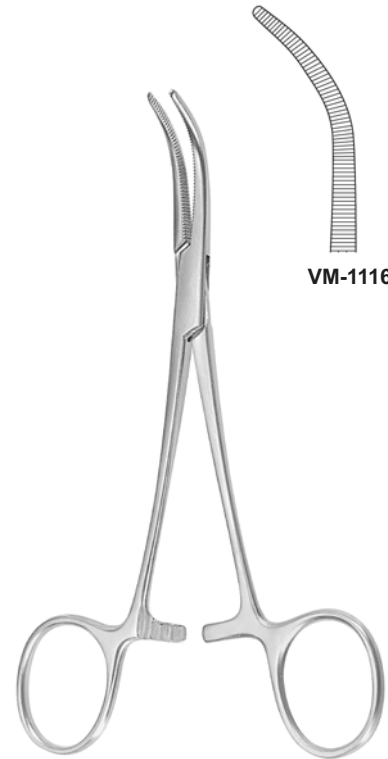

**BABY-OVERHOLT** 13,5  
 cm, 5 1/4"  
**VM-1115**

**VM-1116**

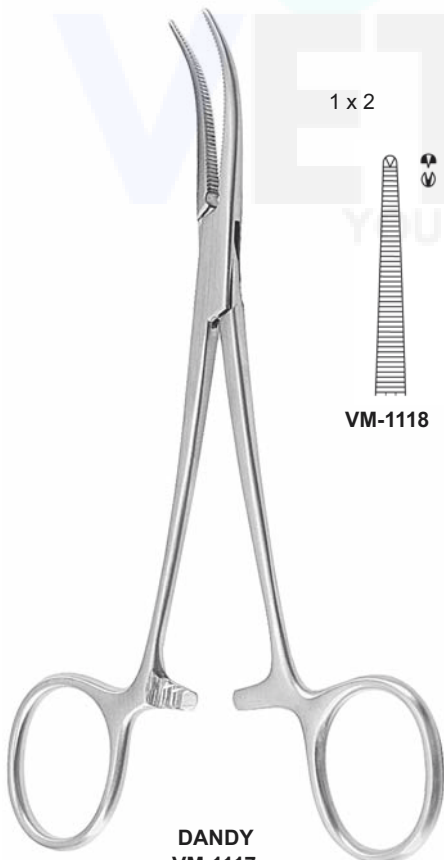

**DANDY**  
**VM-1117**  
 14,0 cm, 5 1/2"

1 x 2



**VM-1118**



**CRILE**  
**VM-1119**  
 14,0 cm, 5 1/2"



**VM-1120**



**VM-1121**

1 x 2



**VM-1122**

1 x 2



**VM-1123**

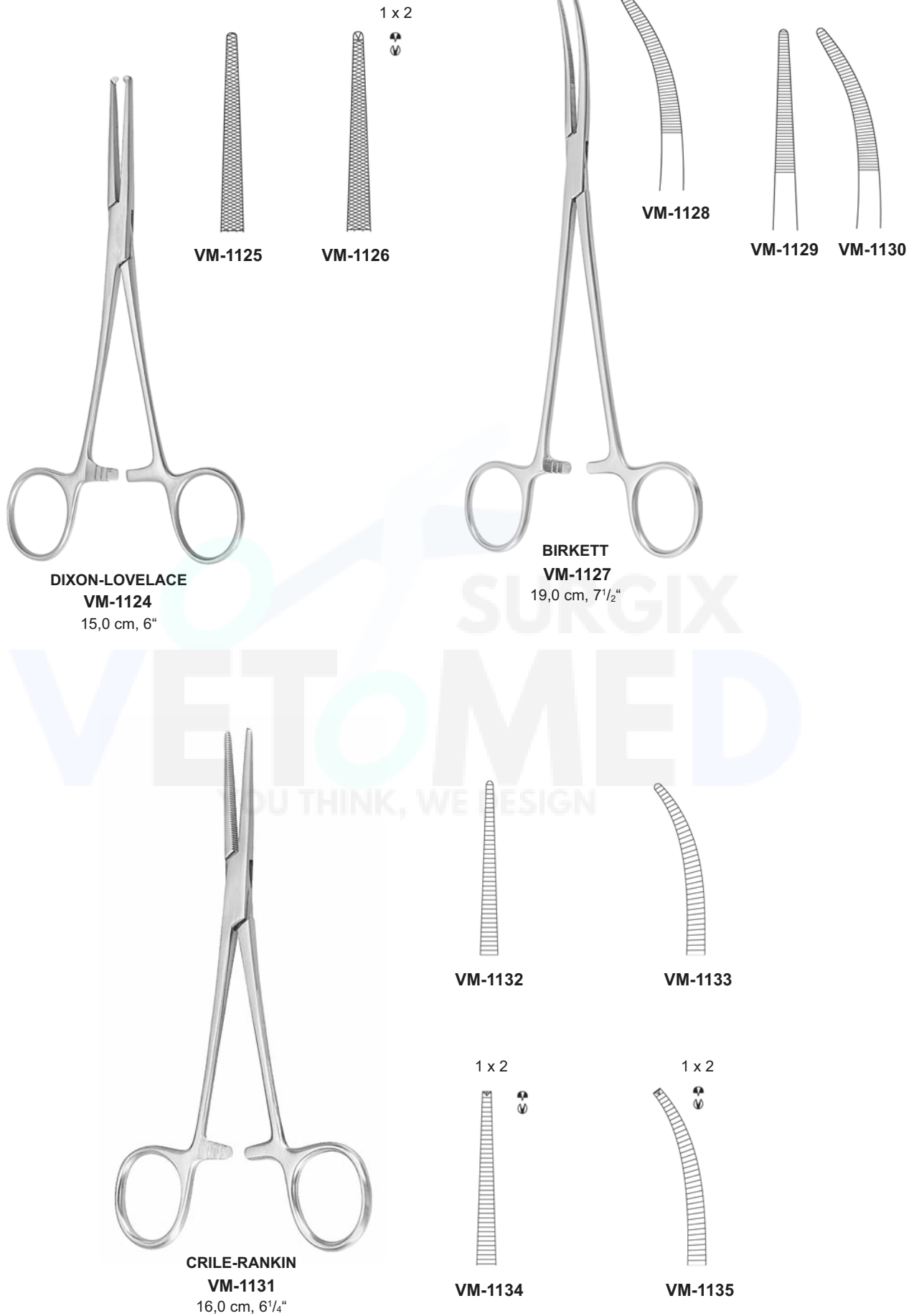





**SCHNIDT**  
**VM-1136**  
 19,0 cm, 7 1/2"

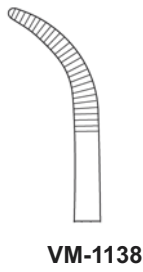
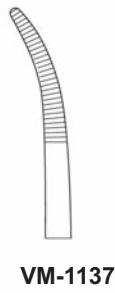

**SCHNIDT-SAWTELL**  
**VM-1139**  
 19,0 cm, 7 1/2"

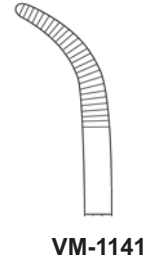
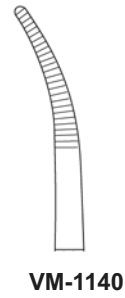

**ADSON**  
**VM-1142**  
 18,5 cm, 7 1/4"

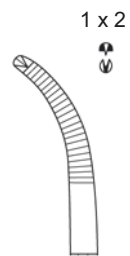
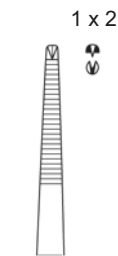
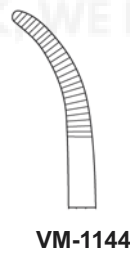
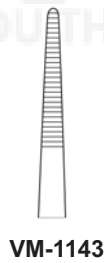

**CRAFOORD**  
**VM-1147**  
 24,0 cm, 9 1/2"

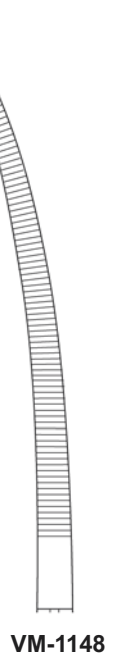



**BAINBRIDGE**  
**VM-1149**

15,0 cm, 6"  
 18,5 cm, 7 1/4"

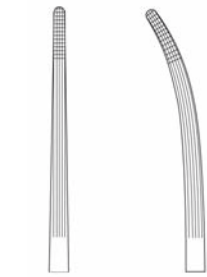

**VM-1150**    **VM-1151**



**ROCHESTER-CARMALT**  
**VM-1152**

16,0 cm, 6 1/4"  
 20,0 cm, 8"

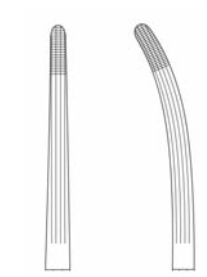

**VM-1153**    **VM-1154**



**PEAN DELICATE**  
**VM-1155**

13,0 cm, 5"  
 14,0 cm, 5 1/2"  
 16,0 cm, 6 1/4"

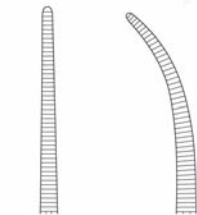

**VM-1156**    **VM-1157**



**KOCHER DELICATE**  
**VM-1158**

13,0 cm, 5"  
 14,0 cm, 5 1/2"  
 16,0 cm, 6 1/4"

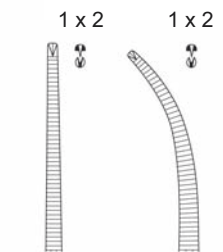

**VM-1159**    **VM-1160**



**ROCHESTER-PEAN**  
**VM-1161**

14,0 cm, 5½"  
 16,0 cm, 6¼"  
 18,0 cm, 7"  
 20,0 cm, 8"  
 22,0 cm, 8⅝"  
 24,0 cm, 9½"  
 26,0 cm, 10¼"  
 30,0 cm, 12"

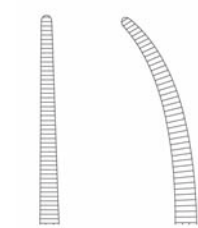

**VM-1162** **VM-1163**



**KOCHER-OCHSNER**  
**VM-1164**

14,0 cm, 5½"  
 16,0 cm, 6¼"  
 18,0 cm, 7"  
 20,0 cm, 8"  
 22,0 cm, 8⅝"  
 24,0 cm, 9½"  
 26,0 cm, 10¼"  
 30,0 cm, 12"

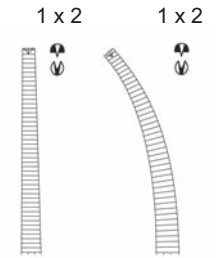

**VM-1165** **VM-1166**



**BENGOLEA**  
**VM-1167**

20,0 cm, 8"  
 26,0 cm, 10¼"

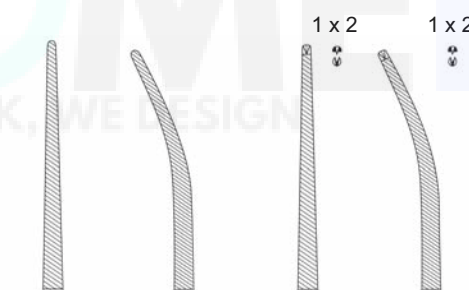

**VM-1168** **VM-1169** **VM-1170** **VM-1171**

## Dissecting Ligature Forceps



**BABY-ADSON**  
VM-1185



**VM-1186**  
14,0 cm, 5 1/2"

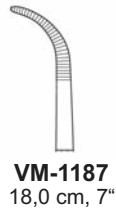

**VM-1187**  
18,0 cm, 7"



**MICRO-ADSON**  
VM-1188  
14,0 cm, 5"



**VM-1189**



**BABY-MIXTER**  
VM-1190  
18,0 cm, 7"

**VM-1191**



**OVERHOLT-MIXTER**  
VM-1192  
21,0 cm, 8 1/4"

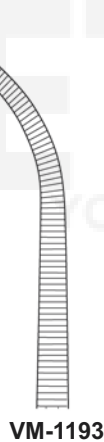

**VM-1193**

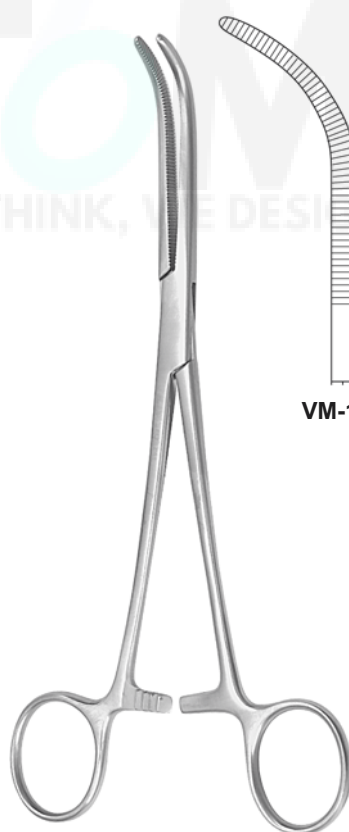

**JOHNS HOPKINS**  
VM-1194  
20,0 cm, 8"

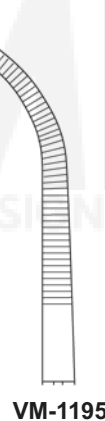

**VM-1195**

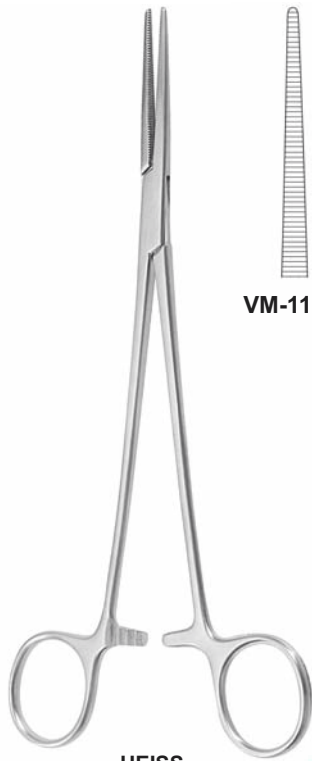

**HEISS**  
**VM-1172**  
20,0 cm, 8"

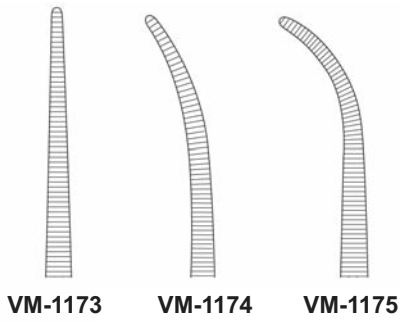

**ROBERTS**  
**VM-1176**  
22,0 cm, 8<sup>5</sup>/<sub>8</sub>"

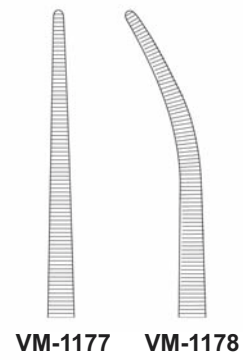

**SAROT**  
**VM-1179**  
24,0 cm, 9<sup>1</sup>/<sub>2</sub>"

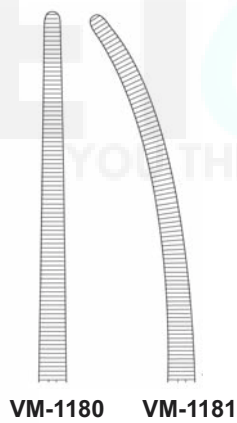

**NEGUS**  
**VM-1182**  
19,0 cm, 7<sup>1</sup>/<sub>2</sub>"

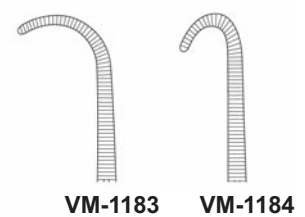

## Dissecting Ligature Forceps



OVERHOLT  
VM-1196



VM-1197  
18,5 cm, 7 1/4"

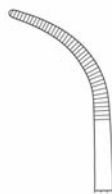

VM-1198  
20,0 cm, 8"

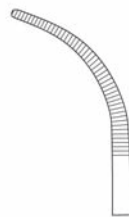

VM-1199  
21,0 cm, 8 1/4"

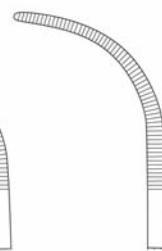

VM-1200  
21,5 cm, 8 1/2"



RUMEL  
VM-1201  
23,0 cm, 9"



VM-1202



VM-1203



VM-1204

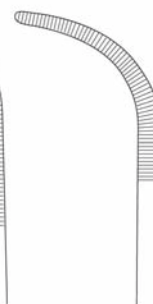

VM-1205

# Dissecting Ligature Forceps



**OVERHOLT-GEISSENDOERFER**  
**VM-1206**

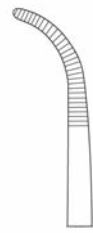

**VM-1207**  
 19,5 cm, 7<sup>3</sup>/<sub>4</sub>"



**VM-1208**  
 19,0 cm, 7<sup>1</sup>/<sub>2</sub>"

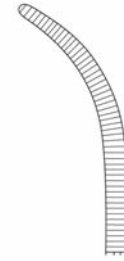

**VM-1209**  
 21,0 cm, 8<sup>1</sup>/<sub>4</sub>"

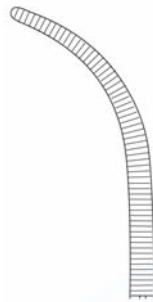

**VM-1210**  
 22,0 cm, 8<sup>3</sup>/<sub>4</sub>"

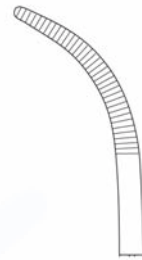

**VM-1211**  
 21,5 cm, 8<sup>1</sup>/<sub>2</sub>"

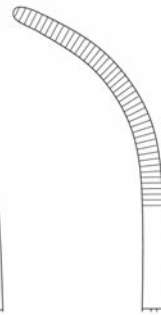

**VM-1212**  
 22,0 cm, 8<sup>3</sup>/<sub>4</sub>"



**VM-1213**  
 22,0 cm, 8<sup>3</sup>/<sub>4</sub>"



**OVERHOLT-GEISSENDOERFER**  
**VM-1214**



**VM-1100**  
 27,0 cm, 10<sup>3</sup>/<sub>4</sub>"

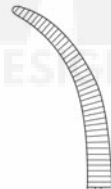

**VM-1100**  
 26,0 cm, 10<sup>1</sup>/<sub>4</sub>"

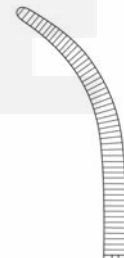

**VM-1100**  
 27,0 cm, 10<sup>3</sup>/<sub>4</sub>"

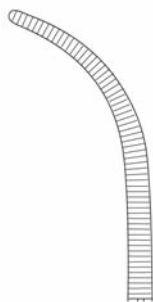

**VM-1215**  
 27,5 cm, 10<sup>3</sup>/<sub>4</sub>"

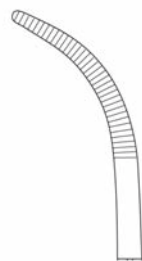

**VM-1216**  
 27,5 cm, 10<sup>3</sup>/<sub>4</sub>"

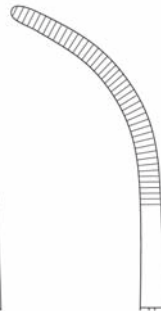

**VM-1217**  
 28,0 cm, 11"



**VM-1218**  
 28,0 cm, 11"



**TOENNIS**  
**VM-1219**

$\frac{21,0 \text{ cm}, 8\frac{1}{4}''}{26,0 \text{ cm}, 10\frac{1}{4}''}$

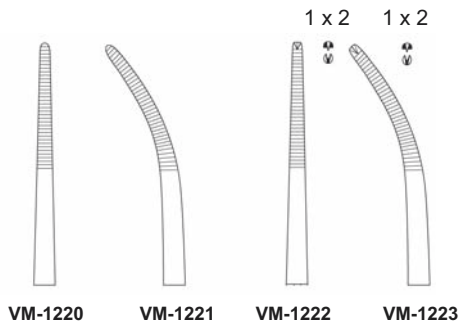

VM-1220

VM-1221

VM-1222

VM-1223



**KELLY**  
**VM-1224**

$\frac{19,0 \text{ cm}, 7\frac{1}{2}''}{22,0 \text{ cm}, 8\frac{5}{8}''}{24,0 \text{ cm}, 9\frac{1}{2}''}$

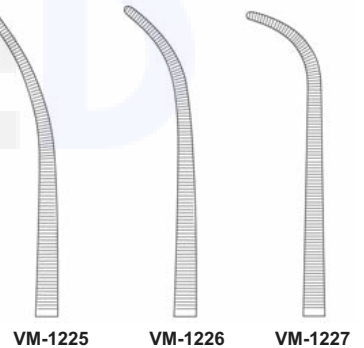

VM-1225

VM-1226

VM-1227



## Dissecting Ligature Forceps

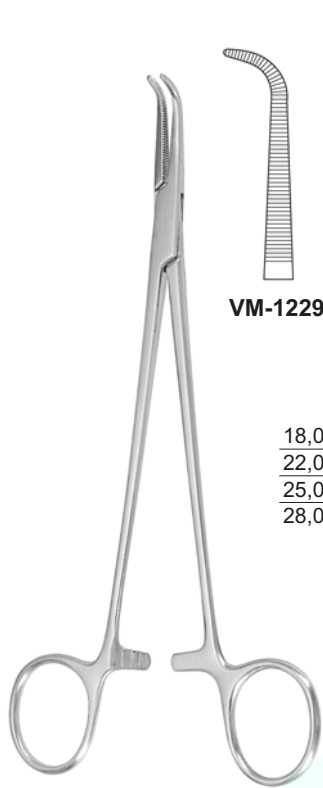

**VM-1229**

18,0 cm, 7"  
 22,0 cm, 8<sup>5</sup>/<sub>8</sub>"  
 25,0 cm, 9<sup>3</sup>/<sub>4</sub>"  
 28,0 cm, 11"

**MINI-GEMINI**  
**VM-1228**

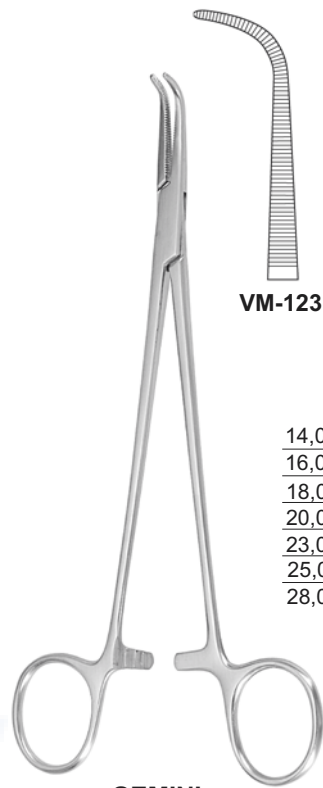

**VM-1231**

14,0 cm, 5<sup>1</sup>/<sub>2</sub>"  
 16,0 cm, 6<sup>1</sup>/<sub>4</sub>"  
 18,0 cm, 7"  
 20,0 cm, 8"  
 23,0 cm, 9"  
 25,0 cm, 9<sup>3</sup>/<sub>4</sub>"  
 28,0 cm, 11"

**GEMINI**  
**VM-1230**

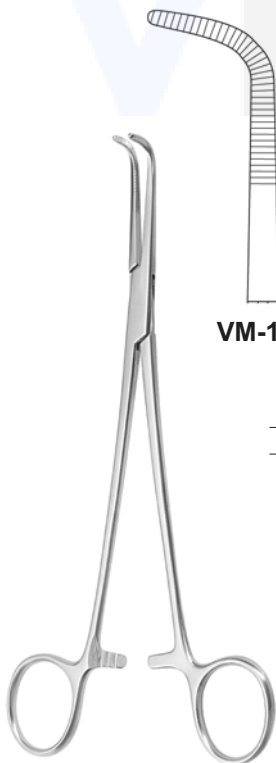

**VM-1233**

20,0 cm, 8"  
 24,0 cm, 9<sup>1</sup>/<sub>2</sub>"  
 28,0 cm, 11"

**KANTROWITZ**  
**VM-1232**

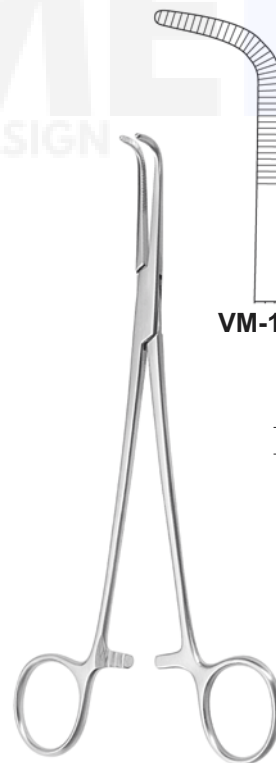

**VM-1235**

19,0 cm, 7<sup>1</sup>/<sub>2</sub>"  
 21,0 cm, 8<sup>1</sup>/<sub>4</sub>"  
 24,0 cm, 9<sup>1</sup>/<sub>2</sub>"

**WIKSTROEM**  
**VM-1234**

## Dissecting Ligature Forceps

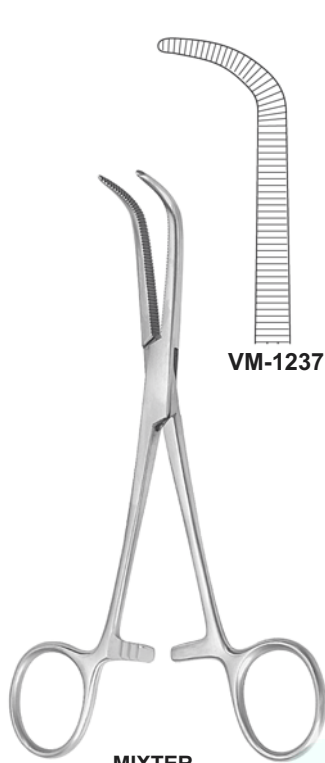

VM-1237

**MIXTER**  
**VM-1236**  
 15,5 cm, 6"  
 19,0 cm, 7 1/2"

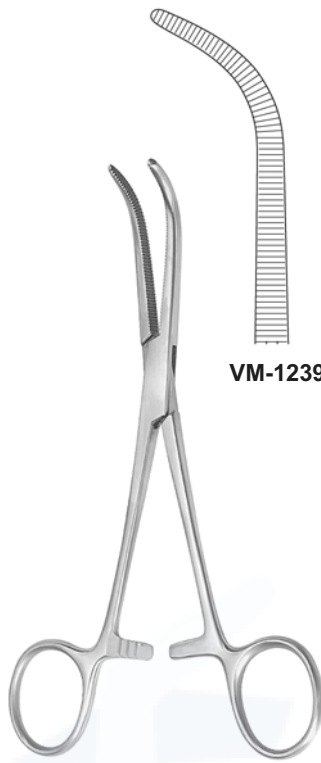

VM-1239

**MIXTER-O'SHAUGNESSY**  
**VM-1238**  
 15,5 cm, 6"  
 19,0 cm, 7 1/2"

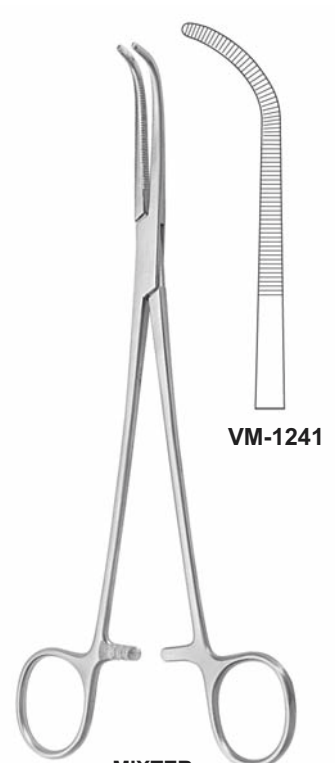

VM-1241

**MIXTER**  
**VM-1240**  
 22,0 cm, 8 3/4"



VM-1243

**MIXTER**  
**VM-1242**  
 23,0 cm, 9"

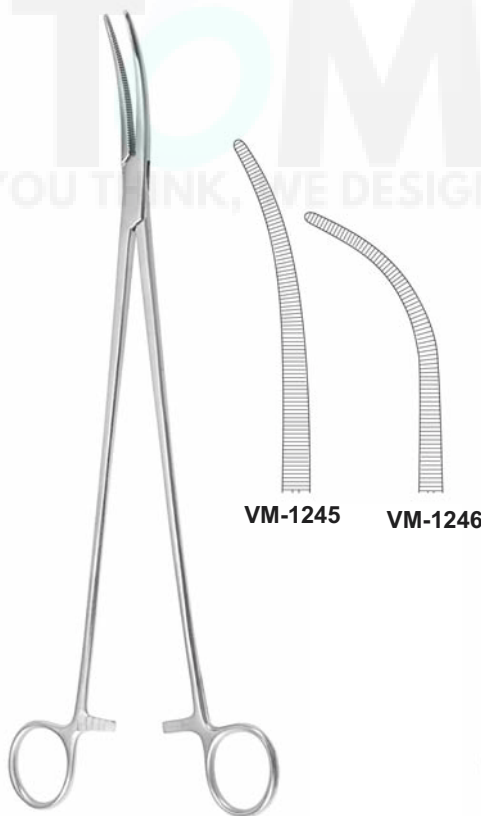

VM-1245

VM-1246

**ZENKER**  
**VM-1244**



VM-1248

VM-1249

**ZENKER**  
**VM-1247**

# Dissecting Ligature Forceps

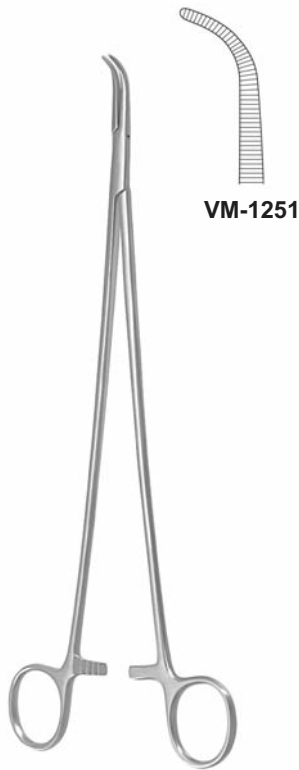

**LAWRENCE**  
**VM-1250**  
 27,5 cm, 10<sup>3</sup>/<sub>4</sub>"

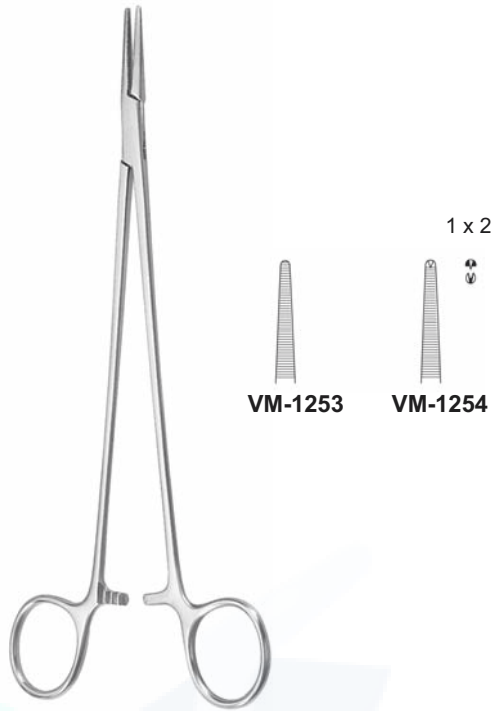

**HOSEMANN**  
**VM-1252**  
 21,0 cm, 8<sup>1</sup>/<sub>4</sub>"



**DESJARDINS**  
**VM-1255**  
 21,0 cm, 8<sup>1</sup>/<sub>4</sub>"

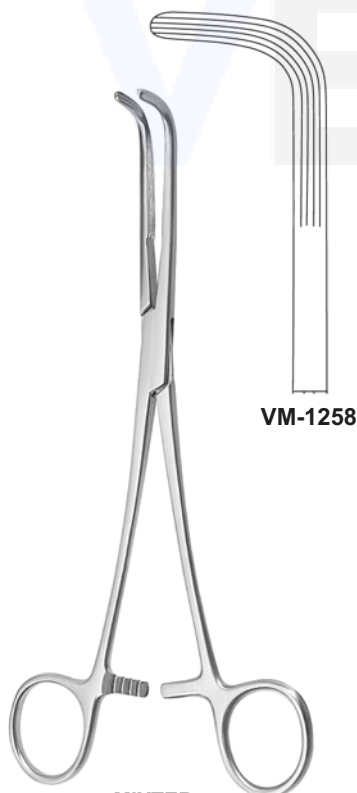

**MIXTER**  
**VM-1257**  
 22,0 cm, 8<sup>3</sup>/<sub>4</sub>"  
 25,0 cm, 9<sup>3</sup>/<sub>4</sub>"  
 28,0 cm, 11"

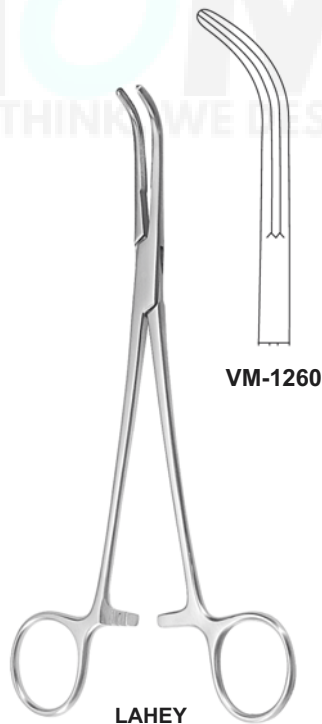

**LAHEY**  
**VM-1259**  
 19,0 cm, 7<sup>1</sup>/<sub>2</sub>"  
 23,0 cm, 9"



**LOWER**  
**VM-1261**  
 18,0 cm, 7"

# Dissecting Ligature Forceps

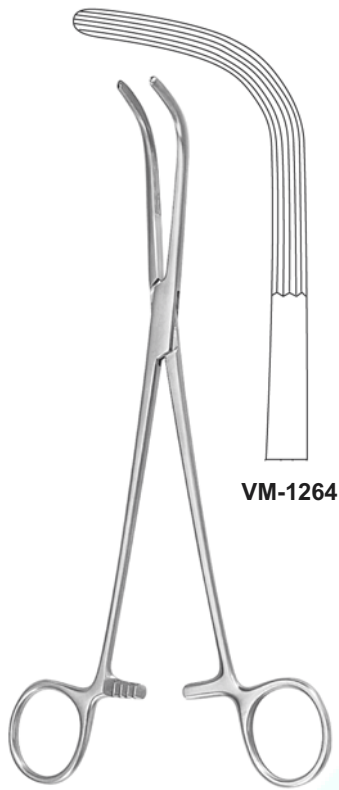

VM-1264

MC QUIGG-MIXTER  
 VM-1263  
 22,0 cm, 8<sup>3</sup>/<sub>4</sub>"

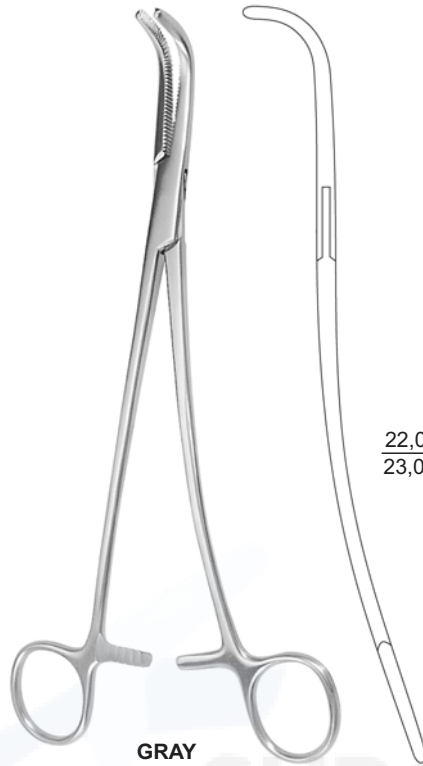

GRAY  
 VM-1265

22,0 cm, 8<sup>3</sup>/<sub>4</sub>"  
 23,0 cm, 9"

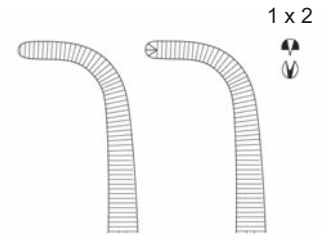

VM-1266 VM-1267

1 x 2



CRAFOORD-SELLORS  
 VM-1268

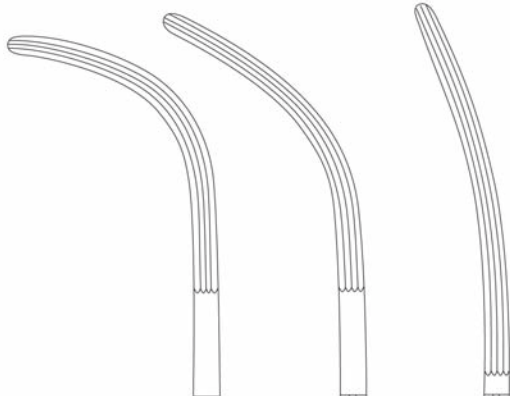

VM-1269  
 22,0 cm, 8<sup>3</sup>/<sub>4</sub>"

VM-1270  
 23,0 cm, 9"

VM-1271  
 24,0 cm, 9<sup>1</sup>/<sub>2</sub>"

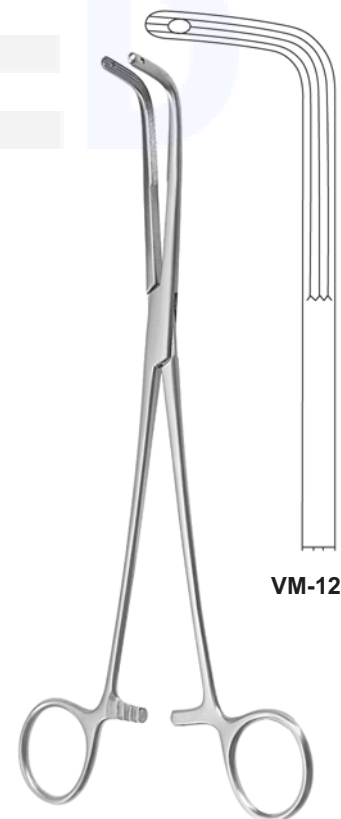

VM-1273

FINOCCHIETTO  
 VM-1272  
 24,0 cm, 9<sup>1</sup>/<sub>2</sub>"

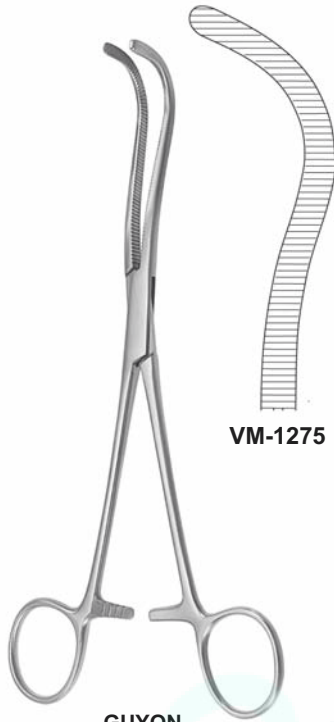

VM-1275

GUYON  
VM-1274

20,0 cm, 8"  
22,0 cm, 8<sup>3</sup>/<sub>4</sub>"  
24,0 cm, 9<sup>1</sup>/<sub>2</sub>"

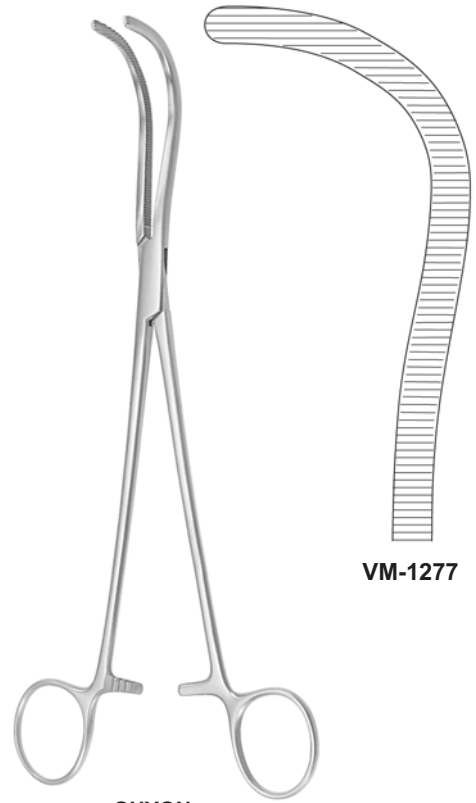

VM-1277

GUYON  
VM-1276

23,0 cm, 9"



23,0 cm, 9"  
VM-1279

24,0 cm, 9<sup>1</sup>/<sub>2</sub>"  
VM-1280

GUYON  
VM-1278

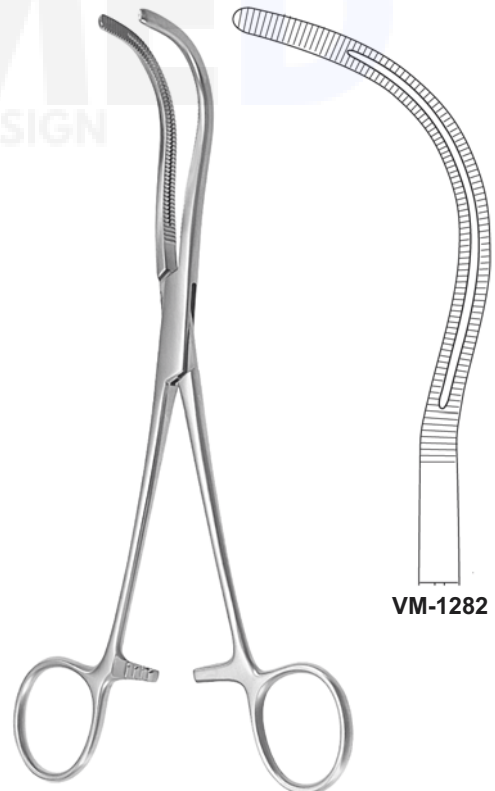

VM-1282

STILLE  
VM-1281  
23,0 cm, 9"



**HERRICK**  
**VM-1283**  
 23,0 cm, 9"

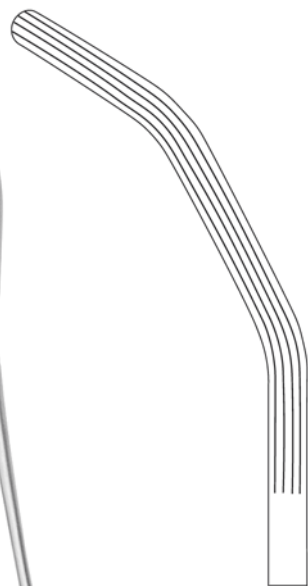

**VM-1284**



**URO-TANGENTIAL**  
**VM-1285**  
 26,0 cm, 10 1/4"



**VM-1286**  
 23,0 cm, 9"



**VM-1287**  
 24,0 cm, 9 1/2"



**LOVELACE**  
**VM-1288**  
 20,0 cm, 8"

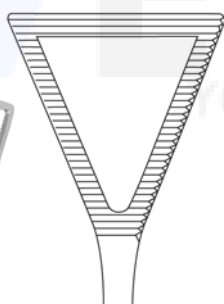

**VM-1289**



**LOVELACE**  
**VM-1290**  
 20,0 cm, 8"

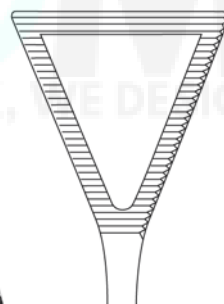

**VM-1291**



**PRICE-THOMAS**  
**VM-1292**  
 22,0 cm, 8 3/4"



**VM-1293**



**PRICE-THOMAS**  
**VM-1294**  
 22,0 cm, 8<sup>3</sup>/<sub>4</sub>"

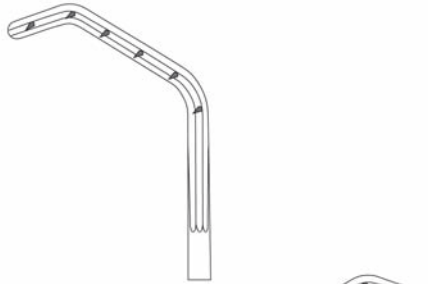

**VM-1295**

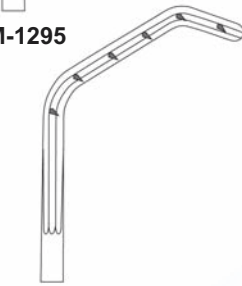

**VM-1296**



**SEMB**  
**VM-1297**  
 24,0 cm, 9<sup>1</sup>/<sub>2</sub>"

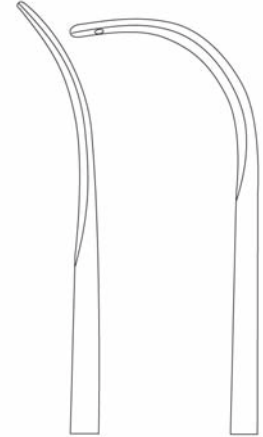

**VM-1298**



**VM-1299**

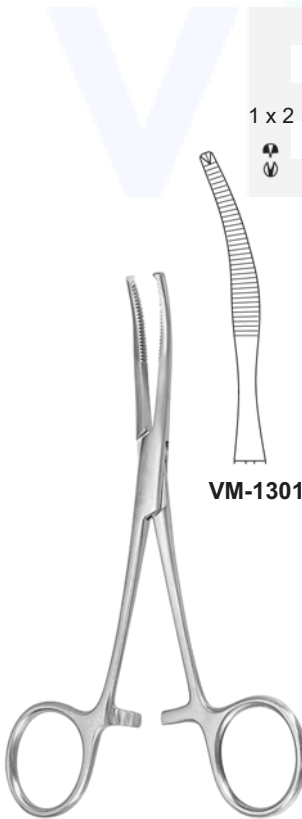

**BABY-MIKULICZ**  
 14cm, 5<sup>1</sup>/<sub>2</sub>"  
**VM-1300**



**VM-1301**

1 x 2

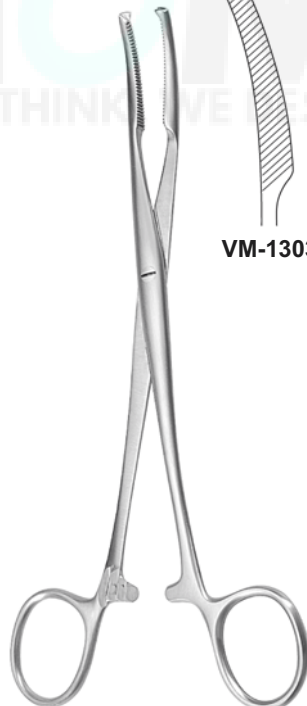

**MIKULICZ**  
**VM-1302**  
 18,0 cm, 7"



**VM-1303**

1 x 2

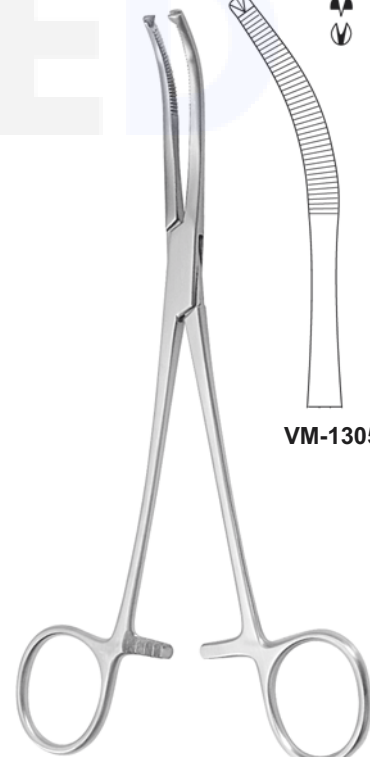

**MIKULICZ**  
**VM-1304**  
 20,0 cm, 8"

1 x 2

**VM-1305**



1 x 2  
 VM-1307

1 x 2  
 VM-1308

**FAURE**  
**VM-1306**  
 20,0 cm, 8"



1 x 2  
 VM-1310

1 x 2  
 VM-1311

**PHANEUF**  
**VM-1309**  
 21,5 cm, 8 1/2"



1 x 2  
 VM-1313

**WERTHEIM**  
**VM-1312**  
 24,0 cm, 9 1/2"

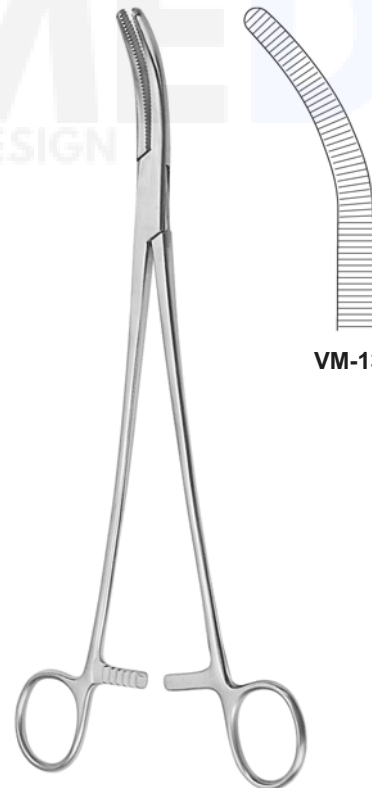

VM-1315

**WERTHEIM**  
**VM-1314**  
 25,0 cm, 10"







**STANDARD  
 VM-1316**

10,5 cm, 4 <sup>1</sup> / <sub>8</sub> "
11,5 cm, 4 <sup>1</sup> / <sub>2</sub> "
13,0 cm, 5"
14,5 cm, 5 <sup>3</sup> / <sub>4</sub> "
15,0 cm, 6"
16,0 cm, 6 <sup>1</sup> / <sub>4</sub> "
18,0 cm, 7"
20,0 cm, 8"
25,0 cm, 10"
30,0 cm, 12"



narrow

**STANDARD  
 VM-1317**

10,5 cm, 4 <sup>1</sup> / <sub>8</sub> "
11,5 cm, 4 <sup>1</sup> / <sub>2</sub> "
13,0 cm, 5"
14,5 cm, 5 <sup>3</sup> / <sub>4</sub> "
15,0 cm, 6"
16,0 cm, 6 <sup>1</sup> / <sub>4</sub> "
18,0 cm, 7"
20,0 cm, 8"
25,0 cm, 10"
30,0 cm, 12"



narrow

**STANDARD  
 VM-1318**

10,5 cm, 4 <sup>1</sup> / <sub>8</sub> "
11,5 cm, 4 <sup>1</sup> / <sub>2</sub> "
13,0 cm, 5"
14,5 cm, 5 <sup>3</sup> / <sub>4</sub> "
15,0 cm, 6"
16,0 cm, 6 <sup>1</sup> / <sub>4</sub> "
18,0 cm, 7"
20,0 cm, 8"
25,0 cm, 10"
30,0 cm, 12"



fine

**STANDARD  
 VM-1319**

10,5 cm, 4 <sup>1</sup> / <sub>8</sub> "
11,5 cm, 4 <sup>1</sup> / <sub>2</sub> "
13,0 cm, 5"
14,5 cm, 5 <sup>3</sup> / <sub>4</sub> "
15,0 cm, 6"
16,0 cm, 6 <sup>1</sup> / <sub>4</sub> "
18,0 cm, 7"
20,0 cm, 8"
25,0 cm, 10"
30,0 cm, 12"



**VM-1320**

10,5 cm, 4 <sup>1</sup> / <sub>8</sub> "
11,5 cm, 4 <sup>1</sup> / <sub>2</sub> "
13,0 cm, 5"
14,5 cm, 5 <sup>3</sup> / <sub>4</sub> "
16,0 cm, 6 <sup>1</sup> / <sub>4</sub> "
18,0 cm, 7"
20,0 cm, 8"
25,0 cm, 10"
30,0 cm, 12"



**VM-1321**

10,5 cm, 4 <sup>1</sup> / <sub>8</sub> "
11,5 cm, 4 <sup>1</sup> / <sub>2</sub> "
13,0 cm, 5"
14,5 cm, 5 <sup>3</sup> / <sub>4</sub> "
16,0 cm, 6 <sup>1</sup> / <sub>4</sub> "
18,0 cm, 7"
20,0 cm, 8"
25,0 cm, 10"
30,0 cm, 12"



**MOD. USA  
 VM-1322**

12,0 cm, 4 <sup>3</sup> / <sub>4</sub> "
13,0 cm, 5"
14,5 cm, 5 <sup>3</sup> / <sub>4</sub> "
15,0 cm, 6"
18,0 cm, 7"
20,0 cm, 8"
25,5 cm, 10"
30,0 cm, 12"



**MOD. USA  
 VM-1323**

12,0 cm, 4 <sup>3</sup> / <sub>4</sub> "
13,0 cm, 5"
14,5 cm, 5 <sup>3</sup> / <sub>4</sub> "
15,0 cm, 6"
18,0 cm, 7"
20,0 cm, 8"
25,5 cm, 10"



**ADSON**  
**VM-1324**  
 12,0 cm, 4<sup>3</sup>/<sub>4</sub>"  
 15,0 cm, 6"



**MICRO-ADSON**  
**VM-1325**  
 12,0 cm, 4<sup>3</sup>/<sub>4</sub>"  
 15,0 cm, 6"



**STILLE**  
**VM-1326**  
 15,0 cm, 6"



**MC INDOE**  
**VM-1327**  
 15,0 cm, 6"



**TAYLOR**  
**VM-1328**  
 17,5 cm, 6<sup>5</sup>/<sub>8</sub>"



**TAYLOR**  
**VM-1329**  
 17,5 cm, 6<sup>5</sup>/<sub>8</sub>"



**TAYLOR**  
**VM-1330**  
 18,5 cm, 7<sup>1</sup>/<sub>4</sub>"



**GERALD**  
**VM-1331**  
 18,0 cm, 7"



**GERALD**  
**VM-1332**  
 18,0 cm, 7"



**POTTS-SMITH**  
**VM-1333**  
 18,0 cm, 7"  
 21,0 cm, 8<sup>1</sup>/<sub>4</sub>"  
 25,0 cm, 10"



**POTTS-SMITH**  
**VM-1334**  
 18,0 cm, 7"  
 21,0 cm, 8<sup>1</sup>/<sub>4</sub>"  
 25,0 cm, 10"



english patterns

**VM-1335**  
 13,0 cm, 5"  
 14,5 cm, 5<sup>3</sup>/<sub>4</sub>"  
 15,0 cm, 6"



**SEMKEN**  
**VM-1336**  
 12,5 cm, 5"  
 15,0 cm, 6"



**CUSHING**  
**VM-1337**  
 17,5 cm, 6<sup>5</sup>/<sub>8</sub>"



**CUSHING**  
**VM-1338**  
 17,5 cm, 6<sup>5</sup>/<sub>8</sub>"



**BROPHY**  
**VM-1339**  
 20,0 cm, 8"



**BROPHY**  
VM-1340  
20,0 cm, 8"



**BONNEY**  
VM-1341  
18,0 cm, 7"



**SINGLE-TUTTLE**  
VM-1342  
23,0 cm, 9"



**DENNIS BROWN**  
VM-1343  
20,0 cm, 8"

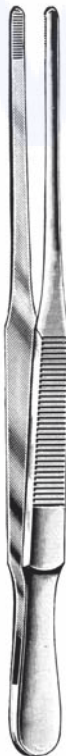

**DUEHRSEN**  
VM-1344  
20,0 cm, 8"



**WAUGH**  
VM-1345  
15,0 cm, 6"  
20,0 cm, 8"



**RAMSEY**  
VM-1346  
18,0 cm, 7"

1 x 2



**STANDARD  
VM-1347**

10,5 cm, 4<sup>1</sup>/<sub>8</sub>"  
11,5 cm, 4<sup>1</sup>/<sub>2</sub>"  
13,0 cm, 5"  
14,5 cm, 5<sup>3</sup>/<sub>4</sub>"  
15,0 cm, 6"  
16,0 cm, 6<sup>1</sup>/<sub>4</sub>"  
18,0 cm, 7"  
20,0 cm, 8"  
25,0 cm, 10"  
30,0 cm, 12"

2 x 3



**VM-1348**

11,5 cm, 4<sup>1</sup>/<sub>2</sub>"  
13,0 cm, 5"  
14,5 cm, 5<sup>3</sup>/<sub>4</sub>"  
16,0 cm, 6<sup>1</sup>/<sub>4</sub>"  
18,0 cm, 7"  
20,0 cm, 8"  
25,0 cm, 10"  
30,0 cm, 12"

3 x 4



**VM-1349**

13,0 cm, 5"  
14,5 cm, 5<sup>3</sup>/<sub>4</sub>"  
16,0 cm, 6<sup>1</sup>/<sub>4</sub>"  
18,0 cm, 7"  
20,0 cm, 8"

4 x 5



**VM-1350**

13,0 cm, 5"  
14,5 cm, 5<sup>3</sup>/<sub>4</sub>"  
16,0 cm, 6<sup>1</sup>/<sub>4</sub>"  
18,0 cm, 7"  
20,0 cm, 8"

1 x 2



fein  
fine  
finas  
fni

**VM-1351**

13,0 cm, 5"  
14,5 cm, 5<sup>3</sup>/<sub>4</sub>"  
15,5 cm, 6"  
16,0 cm, 6<sup>1</sup>/<sub>4</sub>"  
18,0 cm, 7"  
20,0 cm, 8"  
25,0 cm, 10"  
30,0 cm, 12"

1 x 2



with pin

**VM-1352**

13,0 cm, 5"  
14,5 cm, 5<sup>3</sup>/<sub>4</sub>"  
15,5 cm, 6"  
16,0 cm, 6<sup>1</sup>/<sub>4</sub>"  
18,0 cm, 7"  
20,0 cm, 8"  
25,0 cm, 10"  
30,0 cm, 12"

1 x 2



with pin

**VM-1353**

13,0 cm, 5"  
14,5 cm, 5<sup>3</sup>/<sub>4</sub>"  
16,0 cm, 6<sup>1</sup>/<sub>4</sub>"  
18,0 cm, 7"  
20,0 cm, 8"

1 x 2



english patterns

**VM-1354**

13,0 cm, 5"  
14,5 cm, 5<sup>3</sup>/<sub>4</sub>"  
15,0 cm, 6"



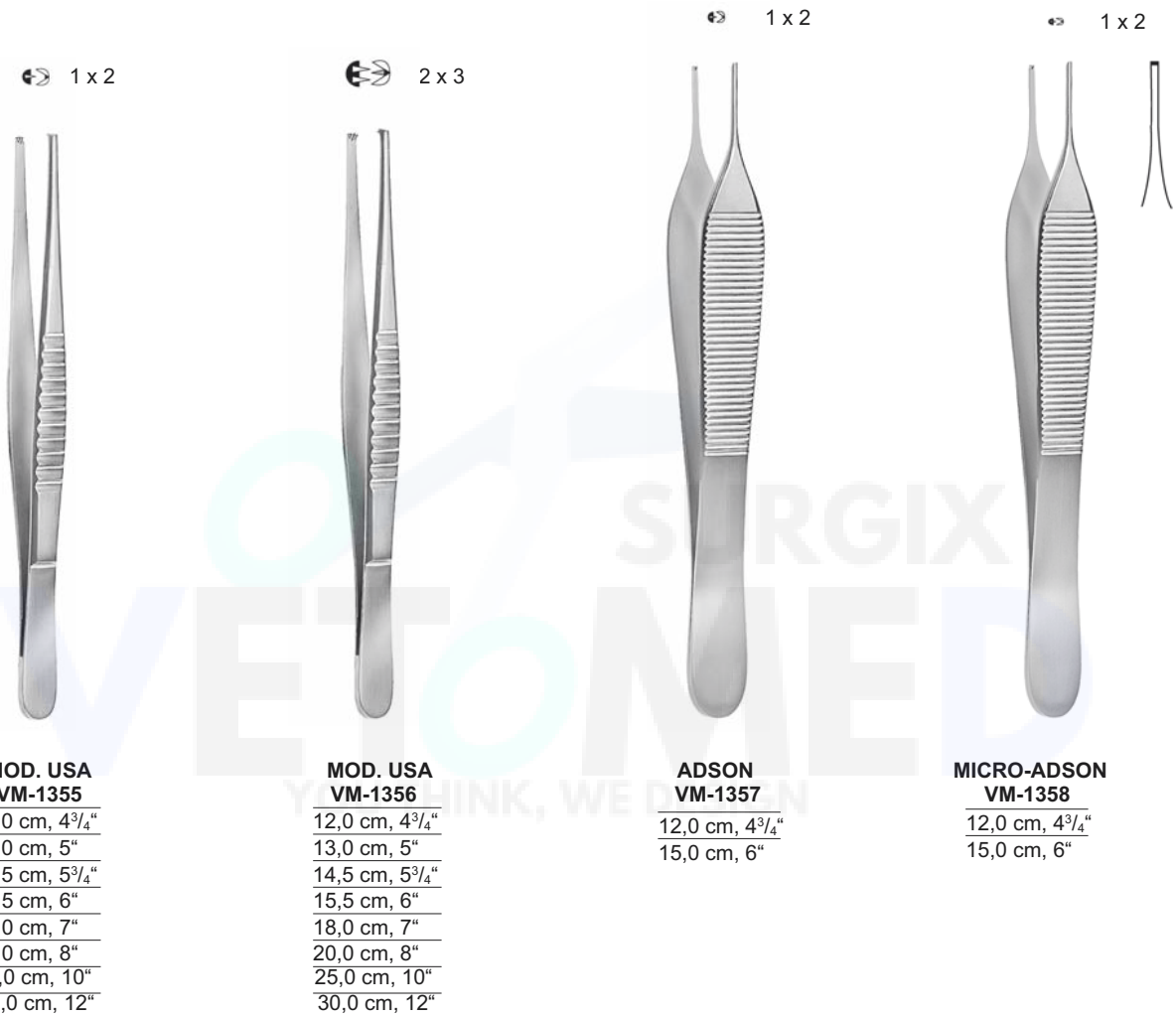

1 x 2



**SEMKEN  
VM-1359**  
12,5 cm, 5"  
15,5 cm, 6"

2 x 3



**SEMKEN  
VM-1360**  
12,5 cm, 5"

1 x 2



**MC INDOE  
VM-1361**  
15,0 cm, 6"

1 x 2



**TAYLOR  
VM-1362**  
17,5 cm, 6<sup>5</sup>/<sub>8</sub>"

1 x 2



**TAYLOR  
VM-1363**  
17,5 cm, 6<sup>5</sup>/<sub>8</sub>"

1 x 2



**TAYLOR  
VM-1364**  
17,5 cm, 6<sup>5</sup>/<sub>8</sub>"

1 x 2



**GERALD  
VM-1365**  
18,0 cm, 7"

1 x 2



**GERALD  
VM-1366**  
18,0 cm, 7"

2 x 3



**ADSON  
VM-1367**

7 x 7



**ADSON-BROWN  
VM-1368**  
12,0 cm, 4<sup>3</sup>/<sub>4</sub>"  
15,0 cm, 6"

1 x 2



**ADSON  
VM-1369**  
12,0 cm, 4<sup>3</sup>/<sub>4</sub>"

1 x 2



**STILLE  
VM-1370**  
15,0 cm, 6"

2 x 3



**STILLE  
VM-1371**  
15,0 cm, 6"

1 x 2



**GILLIES  
VM-1372**  
15,0 cm, 6"

VM-2147

2 x 3



**ADLERKREUTZ  
VM-1373**  
15,0 cm, 6"  
20,0 cm, 8"

VM-2149

4 x 5



**ADLERKREUTZ  
VM-1374**  
15,0 cm, 6"  
20,0 cm, 8"

VM-2151

↔ 1 x 2



**CUSHING  
VM-1375**  
17,5 cm, 6<sup>7</sup>/<sub>8</sub>"

↔ 1 x 2



**CUSHING  
VM-1376**  
17,5 cm, 6<sup>7</sup>/<sub>8</sub>"

↔ 1 x 2



**POTTS-SMITH  
VM-1377**  
18,0 cm, 7"  
21,0 cm, 8<sup>1</sup>/<sub>4</sub>"  
25,0 cm, 10"

↔ 1 x 2



**POTTS-SMITH  
VM-1378**  
18,0 cm, 7"  
21,0 cm, 8<sup>1</sup>/<sub>4</sub>"  
25,0 cm, 10"

↔ 1 x 2



**WAUGH  
VM-1379**  
15,0 cm, 6"  
20,0 cm, 8"

↔ 1 x 2



**BROPHY  
VM-1380**  
20,0 cm, 8"

↔ x 2



**BROPHY  
VM-1381**  
20,0 cm, 8"



**RUSS. MODELL  
VM-1382**  
15,0 cm, 6"  
20,0 cm, 8"  
25,0 cm, 10"



**DURANTE  
VM-1383**  
14,5 cm, 5<sup>3</sup>/<sub>4</sub>"  
16,0 cm, 6<sup>1</sup>/<sub>4</sub>"  
20,0 cm, 8"



**DUEHRSEN  
VM-1384**  
20,0 cm, 8"



1 x 2  
**VM-1385**



2 x 3  
**VM-1386**



1 x 4  
**VM-1387**



**NELSON  
VM-1388**  
15,0 cm, 6"  
20,0 cm, 8"  
23,0 cm, 9"



**DUVAL  
VM-1389**  
14,0 cm, 5<sup>1</sup>/<sub>2</sub>"



Fig. 1



Fig. 2



**COLLIN-DUVAL  
VM-1390**  
20,0 cm, 8"



Fig. 1

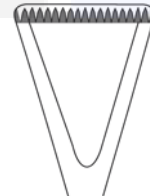

Fig. 2

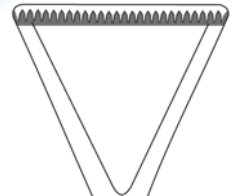

Fig. 3



**LANE**  
**VM-1391**  
 14,5 cm, 5<sup>3</sup>/<sub>4</sub>"  
 20,0 cm, 8"



**LANE**  
**VM-1392**  
 14,5 cm, 5<sup>3</sup>/<sub>4</sub>"  
 20,0 cm, 8"



**BROWN**  
**VM-1393**  
 15,0 cm, 6"  
 20,0 cm, 8"  
 25,0 cm, 10"



**TREVES**  
**VM-1394**  
 13,0 cm, 5"  
 15,0 cm, 6"



**RAMSEY**  
**VM-1396**  
 18,0 cm, 7"



**RAMSEY**  
**VM-1396**  
 18,0 cm, 7"



**RAMSEY**  
**VM-1397**  
 18,0 cm, 7"

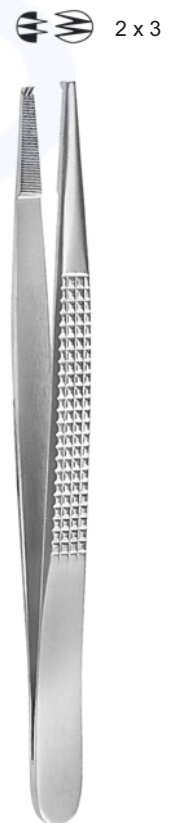

**RAMSEY**  
**VM-1398**  
 18,0 cm, 7"

gerieft



**VM-1399**

8,0 cm, 3<sup>1</sup>/<sub>4</sub>"  
9,0 cm, 3<sup>1</sup>/<sub>2</sub>"  
10,5 cm, 4<sup>1</sup>/<sub>8</sub>"  
11,5 cm, 4<sup>1</sup>/<sub>2</sub>"  
13,0 cm, 5"  
14,5 cm, 5<sup>1</sup>/<sub>2</sub>"

gebogen  
 gerieft



**VM-1400**

8,0 cm, 3<sup>1</sup>/<sub>4</sub>"  
9,0 cm, 3<sup>1</sup>/<sub>2</sub>"  
10,5 cm, 4<sup>1</sup>/<sub>8</sub>"  
11,5 cm, 4<sup>1</sup>/<sub>2</sub>"  
13,0 cm, 5"  
14,5 cm, 5<sup>1</sup>/<sub>2</sub>"

mit Stift



**VM-1401**

8,0 cm, 3<sup>1</sup>/<sub>4</sub>"  
9,0 cm, 3<sup>1</sup>/<sub>2</sub>"  
10,5 cm, 4<sup>1</sup>/<sub>8</sub>"  
11,5 cm, 4<sup>1</sup>/<sub>2</sub>"  
13,0 cm, 5"  
14,5 cm, 5<sup>1</sup>/<sub>2</sub>"

mit Stift  
 gebogen  
 gerieft



**VM-1402**

8,0 cm, 3<sup>1</sup>/<sub>4</sub>"  
9,0 cm, 3<sup>1</sup>/<sub>2</sub>"  
10,5 cm, 4<sup>1</sup>/<sub>8</sub>"  
11,5 cm, 4<sup>1</sup>/<sub>2</sub>"  
13,0 cm, 5"  
14,5 cm, 5<sup>1</sup>/<sub>2</sub>"



**HUNTER**  
**VM-1403**  
 10,5 cm, 4 1/4"



**HUNTER**  
**VM-1404**  
 10,5 cm, 4 1/4"



**WALTER-CARMALT**  
**VM-1405**  
 10,5 cm, 4 1/4"



**WALTER-CARMALT**  
**VM-1406**  
 10,5 cm, 4 1/4"



**FEILCHENFELD**  
**VM-1407**  
 7,5 cm, 3 1/8"  
 9,0 cm, 3 1/2"  
 11,5 cm, 4 1/2"



10,0 cm, 4"  
**VM-1408**



10,0 cm, 4"  
**VM-1409**



10,0 cm, 4"  
**VM-1410**  
 selbsthaltend  
 glatt





**GRAEFE  
VM-1411**  
10,0 cm, 4"



**GRAEFE  
VM-1412**  
10,0 cm, 4"



**GRAEFE  
VM-1413**  
10,0 cm, 4"



**GRAEFE  
VM-1414**  
10,0 cm, 4"



**GRAEFE  
VM-1415**  
10,0 cm, 4"



**GRAEFE  
VM-1416**  
10,0 cm, 4"

## Jeweller's Forceps, Vessel Dilators



Fig. 3  
 11,5 cm, 4 1/2"  
**VM-1417**

0,3 mm x 45°



Fig. 4  
 11,5 cm, 4 1/2"  
**VM-1418**

0,3 mm x 90°



Fig. 5  
 11,5 cm, 4 1/2"  
**VM-1419**

0,3 mm



Fig. 7  
 11,5 cm, 4 1/2"  
**VM-1420**

0,3 mm x 45°



9 mm

11,0 cm, 4 3/8"  
**VM-1421**



9 mm

11,0 cm, 4 3/8"  
**VM-1422**



9 mm

11,0 cm, 4 3/8"  
**VM-1423**



9 mm

diamond coated

11,0 cm, 4 3/8"  
**VM-1424**

## Vessel Dilators, Atraumatic Forceps

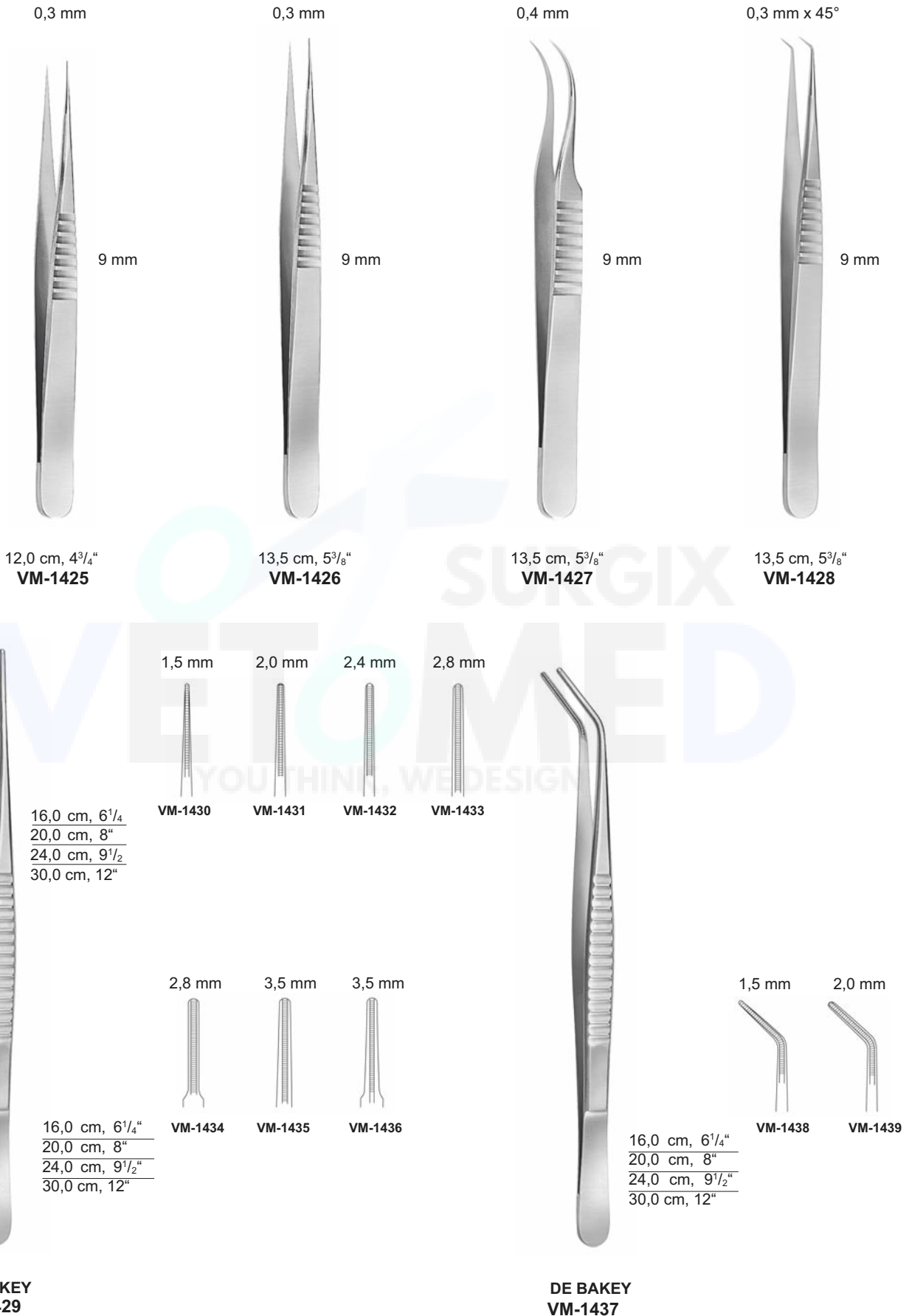



**STANDARD  
 VM-1440**

14,0 cm, 5½"  
 16,0 cm, 6¼"  
 18,0 cm, 7"  
 20,0 cm, 8"  
 25,0 cm, 10"  
 30,0 cm, 12"

**STANDARD  
 VM-1441**

14,0 cm, 5½"  
 16,0 cm, 6¼"  
 18,0 cm, 7"  
 20,0 cm, 8"  
 25,0 cm, 10"  
 30,0 cm, 12"

**STANDARD  
 VM-1442**

12,5 cm, 5"  
 15,0 cm, 6"

**STANDARD  
 VM-1443**

15,0 cm, 6"  
 23,0 cm, 9"  
 25,0 cm, 10"



**GILLIES**  
**VM-1444**  
 15,0 cm, 6"



**MC INDOE**  
**VM-1445**  
 15,0 cm, 6"



**GERALD**  
**VM-1446**  
 17,0 cm, 6<sup>3</sup>/<sub>4</sub>"



**POTTS-SMITH**  
**VM-1449**  
 15,0 cm, 6"  
 18,0 cm, 7"  
 20,0 cm, 8"



**BONNEY**  
**VM-1451**  
 17,5 cm, 6<sup>5</sup>/<sub>8</sub>"



**CUSHING**  
**VM-1453**  
 17,5 cm, 6<sup>5</sup>/<sub>8</sub>"



**CUSHING-TAYLOR**  
**VM-1456**  
 18,0 cm, 7"



**ADSON**  
**VM-1457**  
 17,5 cm, 6<sup>5</sup>/<sub>8</sub>"

**VM-1452**

**VM-1454**

**VM-1455**

12,0 cm, 4<sup>3</sup>/<sub>4</sub>"

12,0 cm, 4<sup>3</sup>/<sub>4</sub>"

15,0 cm, 6"

15,0 cm, 6"



**+92-0311-6977280**



**contact@vetomed surgix.com**



**<https://www.vetomed surgix.com>**



**Plaza No. 17, Giga Downtown, Eucalyptus road,  
Near Lignum Tower, DHA Phase II, Sector I,  
Islamabad**